

Application Note

AN-EVALSF3-ICE3DS01G

**28W-LCD – Monitor SMPS
Evaluation Board with ICE3DS01G**

Author: Harald Zöllinger

Published by Infineon Technologies AG
<http://www.infineon.com/CoolSET>

Power Management & Supply



Never stop thinking

Table of Contents

Table of Contents	1
Introduction.....	2
List of Features.....	3
Power Supply Specification.....	3
Schematic	4
Functional Description	5
PCB Layout and Assembly.....	6
Bill of Material	7
Transformer Construction	8
Performance Data	9
References.....	11

Introduction

Application

This document is an Demoboard description for a low cost universal input LCD – Monitor power supply designed in a typical off line flyback converter topology that utilizes the **ICE3DS01G** controller. The application operates in discontinuous current mode using the burst mode during standby condition. The board has two output voltages with secondary regulation.

The high avalanche rugged CoolMOS™ eliminates or reduces the need for a heatsink and permits a SMPS design with a simply RCD snubber and a low cost standard transformer design. The lowest area specific $R_{ds(on)}$ leads to a high efficiency and permits an operation at high ambient temperature.

ICE3DS01G

This Controller is a current mode control IC and high voltage startup current source within one standard package designed for low cost power supplies. ICE3DS01G together with external CoolMOS combines the optimized technology of the control IC with enhanced protection features and improved standby power concept with the superior technology of CoolMOS™. The integrated propagation delay compensation (patented by Infineon Technologies) prevents a current overshoot, the result is a reduced electrical stress on the MOSFET, the transformer and the output diode.

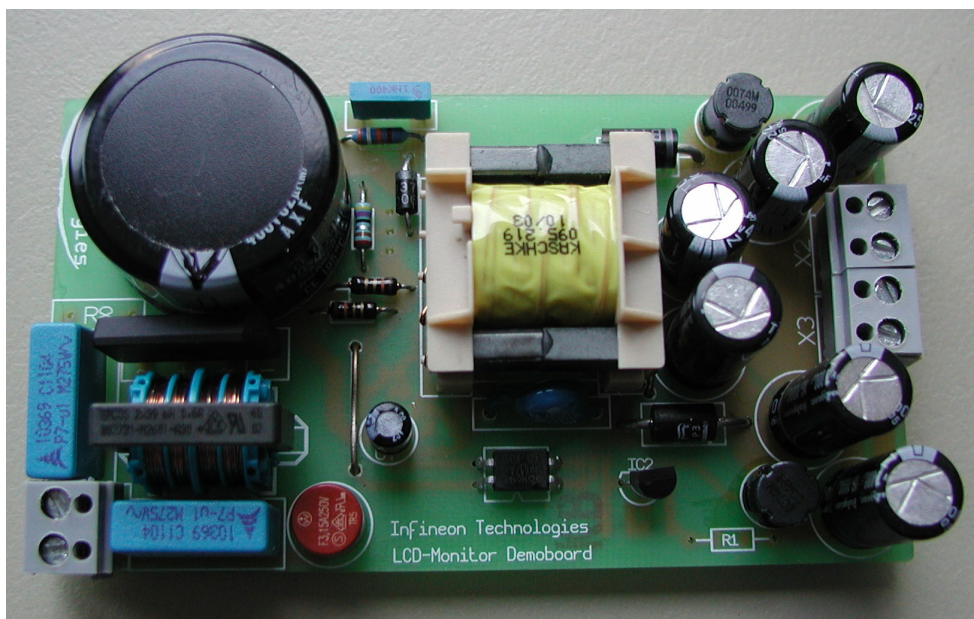

Figure 1– EVALSF3-ICE3DS01G

This document contains the power supply specification, schematic, bill of material and the transformer construction documentation. Typical operating characteristics are presented at the rear of the report and consist of performance curves and scope waveforms.

Note:

Design calculations for the components and the transformer were performed in accordance with the application note “**AN-SMPS-ICE3DS01G for OFF – Line Switch Mode Power Supplies**”, and **FlyCal**, a EXCEL based design software according to the application note AN-SMPS-ICE2AXXX. The application note and FlyCal are available on the Internet: www.infineon.com/CoolSET

List of Features

Feature
Controller ICE3DS01G
External Sense
Adjustable Softstart
Over Load Protection with auto restart
Over Current Protection with auto restart
Over Temperature with latched shutdown
Open Loop Protection with latched shutdown
Under Voltage Lock Out with auto restart
Active Burst Mode
Internal startup current source
Drain Source Voltage 600V
Internal Leading Edge Blanking
110 kHz working frequency
Standby Power according to European Commission

Table 1 – List of Features

Power Supply Specification

Description	Symbol	Min	Typ	Max	Units
Input Section					
Input Voltage	V_{ACIN}	90	115/230	270	V_{AC}
Line Regulation (85...270V)			< 1		%
Input Frequency	f_{ac}	47	50/60	64	Hz
Standby Input Power (240V _{AC}) ¹			< 480		mW
Output Section					
Output Voltage 1	V_{OUT}		5		V_{DC}
Output Voltage Ripple (270V _{AC})	V_{Ripple}		<200		mV _{P-P}
Output Current	I_{OUT}			2	A _{DC}
Output Power	P_{OUT}	0,15		10	W
Output Voltage 2	V_{OUT}		12		V_{DC}
Output Voltage Ripple (270V _{AC})	V_{Ripple}		<200		mV _{P-P}
Output Current	I_{OUT}			1,5	A _{DC}
Output Power	P_{OUT}	0		18	W
Peak Power	P_{OUTmax}		34		W
Load Regulation (10...100%)			< 1		%
Efficiency (90V _{AC})	η		78		%
Efficiency (270V _{AC})	η		80		%
Environmental					
Conducted EMI					EN55022B
Ambient Temperature	T_A	0	60		°C

Table 2 – Power Supply Specification

¹ Pout = 250mW

Schematic

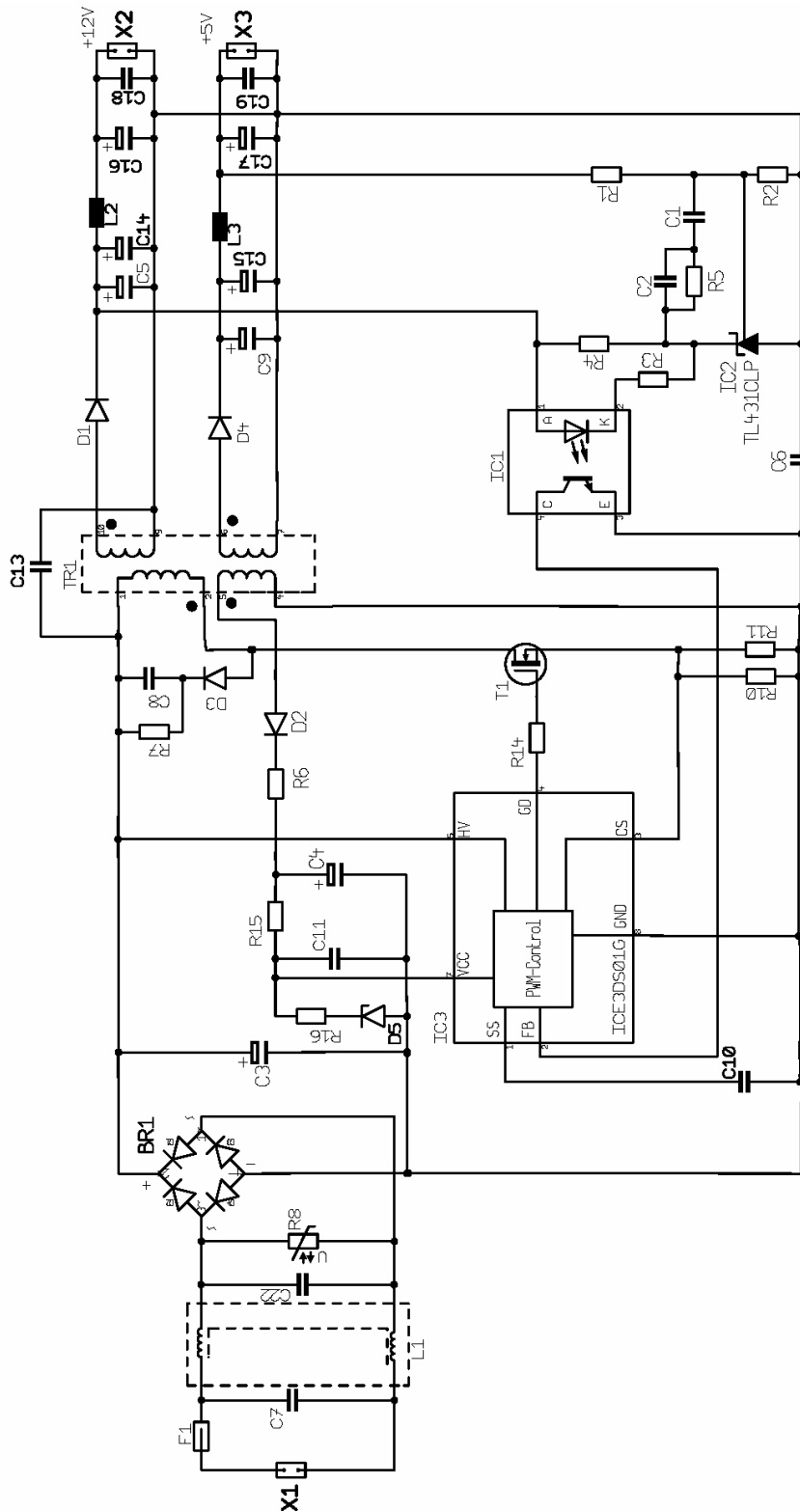

Figure 2 LCD Monitor Supply

Functional Description

Introduction

The **EVALSF3-ICE3DS01G** demoboard is designed as a low cost LCD - Monitor power supply using the ICE3DS01G integrated circuit controller. The circuit shown in Figure 2 details a 5V, 12V 28W supply that operates from an line input voltage range of 85 to 265V_{AC}, suitable for applications requiring low power standby function.

Line Input

The AC line input side comprises of an input fuse F1 as line input over current protection as well as choke L1 and the X2 capacitors C7 and C22 as radio interference suppressors. After the bridge rectifier BR1 and input capacitor C3, a voltage from 120 to 380 V_{DC} is present. Only a 82μF input capacitor is required due to the wide duty cycle DC_{MAX} of the ICE-F3-family.

Startup

The internal current source charges up the chip supply capacitor C4 with a current of approximately 1mA.

Operation Mode

During operation, the V_{CC} pin is supplied via a separate transformer winding with associated rectification D2 and buffering C4. Resistor R6 is used for current limiting during the charging of C4. In order not to exceed the maximum voltage at V_{CC} pin resistor R15 causes an voltage drop of about 1V. Additional an external zener diode D5 can be used to limit this voltage if necessary. During light or no load condition the controller switches over to active burst mode operation order to reduce the switching losses without audible noise.

Softstart

In order to minimize the electrical stress, a Soft-Start function is realized by an internal resistor and the adjustable external capacitor C10.

Snubber Network

Due to the high avalanche rugged CoolMOS™ inside, a simple RCD snubber protection can be used. The network R7, C8 and D3 clamp the DRAIN voltage spike caused by transformer leakage inductance to a safe value below the drain source break down voltage V_{DSBR} = 650V maximum.

Limitation of primary current

The CoolMOS™ drain source current is sensed via external shunt resistors R10 and R11. An accurate value of the shunt improves the peak power limitation shown in the curve peak power limitation in the rear of this report and minimize the electrical stress on MOSFET, Transformer and output rectifier.

Output Voltage

Power is coupled out on the secondary side via a fast-acting diodes D1 and D4 with low forward voltage. Capacitors C5, C14 and C9, C15 performs energy buffering, following LC - filters L2, C16 and L3, C17 considerably reduces the output voltage ripple. The used storage output capacitors C5, C14 and C9, C15 are selected to have a very low ESR in order to minimize the output voltage ripple caused by the triangular current characteristic.

Regulation

The output voltage is controlled using a type TL431 reference diode. This device incorporates the voltage reference as well as the error amplifier and a driver stage. The output voltage is set with resistors R1 and R2. Compensation network C1, C2, R1, R5 constitutes the external circuitry of the error amplifier of IC2. This circuitry allows the feedback to be precisely matched to dynamically varying load conditions, thereby providing stable control. The maximum current through the optocoupler diode and the voltage reference is set by using resistors R3, R4. Optocoupler IC1 is used for floating transmission of the control signal to the "Feedback" input of the ICE3DS01G control device. The optocoupler used meets DIN VDE 884 requirements for a wider creepage distance.

PCB Layout and Assembly

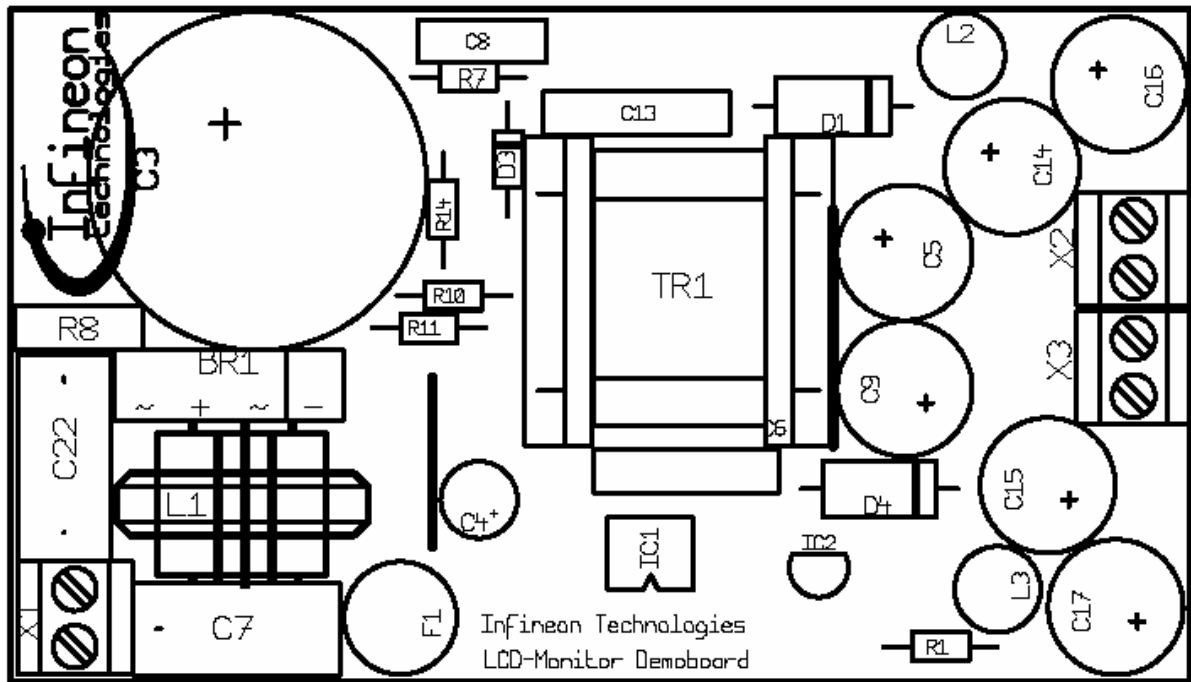

Figure 3 Board Layout - Component Side

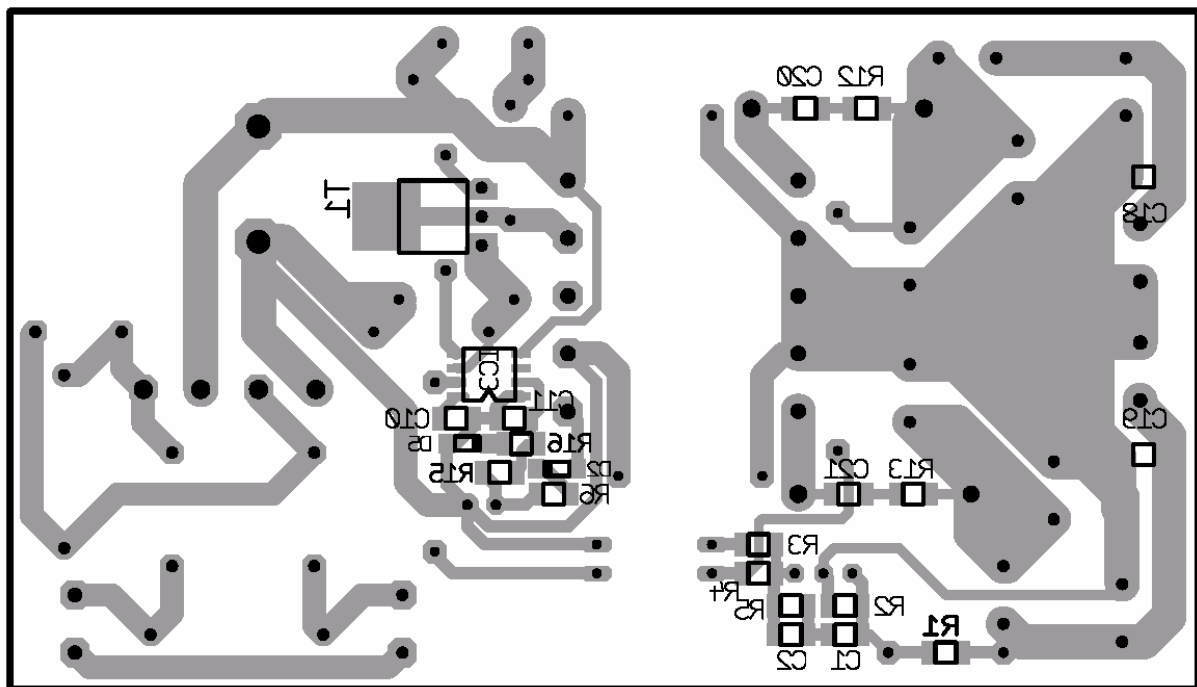

Figure 4 Board Layout - Bottom Side

Bill of Material

Pos.	No P	Part	Type	Grid	Ordering Code	Manufacturer
1	1	BR1	B380 C1500			
2	1	C1	470nF, 25V, X7R	1206		
3	1	C2	3,3nF, 25V, X7R	1206		
4	1	C3	82uF,400V, d30x20	10mm	Rubycon AXF series	
5	1	C4	47uF, 35V	2,5mm		
6	3	C9, C15, C17	1000uF, 16V	5mm	EPCOS B41886-Rubycon ZL series	
7	2	C7, C22	0,1uF, 275V, X2	15mm	B81130-C1104M	EPCOS
8	1	C8	1nF, 400V, MKT	7,5mm		
9	3	C5, C14, C16	470uF, 25V	5mm	EPCOS B41886-Rubycon ZL series	
10	4	C10, C11, C18, C19	1uF, 25V	1206		
11	1	C6	1nF, 250V, Y1	12,5mm	WKP	Vishay
12	1	D1	BYW98-200	15mm		
13	1	D2	LLN4148	MM		
14	1	D3	1N4937	10mm		
15	1	D4	SB540	15mm		
16	1	D5	ZMM20	MM		
17	1	F1	Microfuse 3,15A, F	5mm		
18	1	IC1	SFH617A-3X016	10mm		
19	1	IC2	TL431CLP	TO92		
20	1	IC3	ICE3DS01G	SO8		Infineon
21	1	T1	SPB03N60C3	TO252		Infineon
22	2	W1, W2	Wire			
23	1	L1	39mH, 0,6A		B82731-M2601-A30	EPCOS
24	2	L2, L3	1uH	5mm	744772010	Würth
25	1	R1	4k7, 1%	1206		
26	1	R2	4k7, 1%	1206		
27	1	R3	0,56k	1206		
28	1	R4	1,3k	1206		
29	1	R5	4,7k	1206		
30	1	R6	10R	1206		
31	1	R9	39k, 1W	10mm		
32	1	R10	1,3R, 0,6W, 1%	10mm		
33	1	R11	1,3R, 0,6W 1%	10mm		
34	1	R14	4,7R	10mm		
35	1	R16	100R	1206		
36	1	R15	120R	1206		
37	1	TR1	E25 Bobbin horizontal		see transformer construction	Kaschke
38	3	X1, X2, X3	Connector 2pol.			
39	1		Label			

* = not assembled

Transformer Construction

KUNDE : INFINEON / MÜNCHEN KD-NR. :		TYPE : SP-E 25/7 INDUKT : LI = 326 μ H \pm 5%		Sicherheitsbauteil gemäß: I08			
W	A-E	N	\pm X	Draht	SA	SE	WA
I	2-3	27		0,45 CuL natur [4]			gespreizt
II	10-9	7		3x0,50 TEX-E [5]			gespreizt
III	6-7	3		3x0,50 TEX-E [5]			gespreizt
IV	3-1	27		0,45 CuL natur[4]			gespreizt
V	5-4	8		2x0,45 CuL natur[4]			gespreizt
Kleber Wicklung			Tränkung				
Kleber Kern/Kern			Agomet F305 + Härterlack [9+10]		Verguss		
Kleber Kern/Körper			Agomet F305 + Härterlack [9+10]		Wickelsinn rechts in Pfeilrichtung		Gew.: 25,0g
Elektrische Parameter							
Größe	Einheit	Nennwert	Minimal	Maximal	Meßbedingungen	Prüfmittel	Prüfart
LI+LIV	μ H	326,00	310,00	342,00	50mV/10kHz/25°C	LCR-Meßgerät	100%
Ü		0,00			27:7:2:27:8	LCR-Meßgerät	100%
		0,00					
		0,00					
Hochspannungsprüfung:							
Mechanische Parameter [mm]							
Prüfmaß	Nennwert	Minimal	Maximal	Prüfmittel	Prüfart		
Rastermaße				Rasterlehre L-606/1	NIV III		
freie Stiftlänge	3,50	3,00	4,00	Meßschieber	NIV III		
a.) Aufdruck: Kaschke 095.218 KW/Jahr							
ggf Stift 8 ziehen							
						Vorgang-Nr.: 0759/01/03	
KASCHKE KG GmbH & Co. Göttingen		Sachbearbeiter: DICKHUT		Prüfer Norm Fertigung		Seite 1 von 3 20.02.2003	
						BV-Nummer 095.219.a	

Performance Data

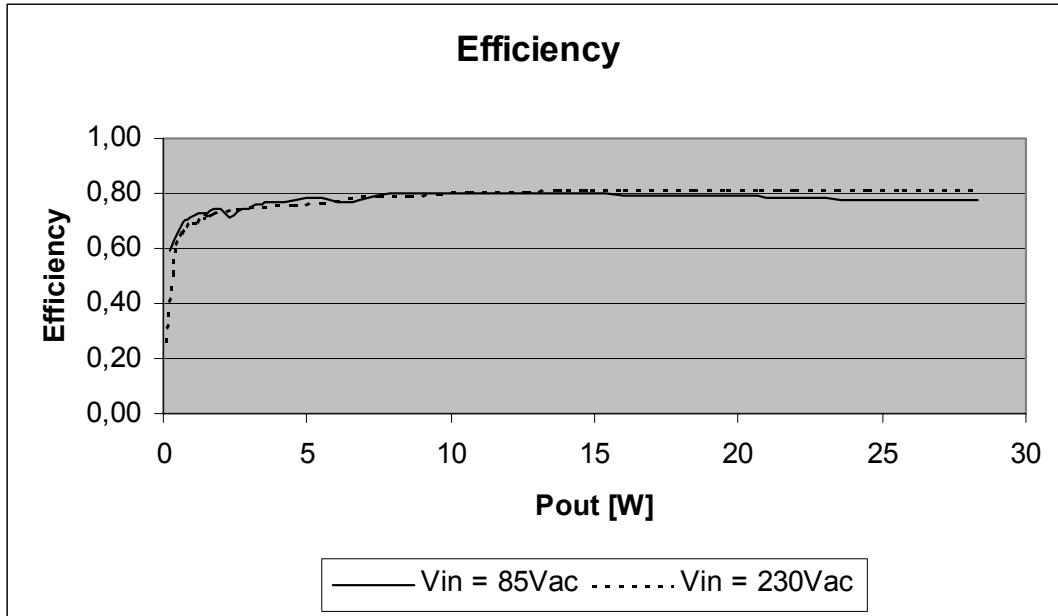

Fig. 5: Efficiency

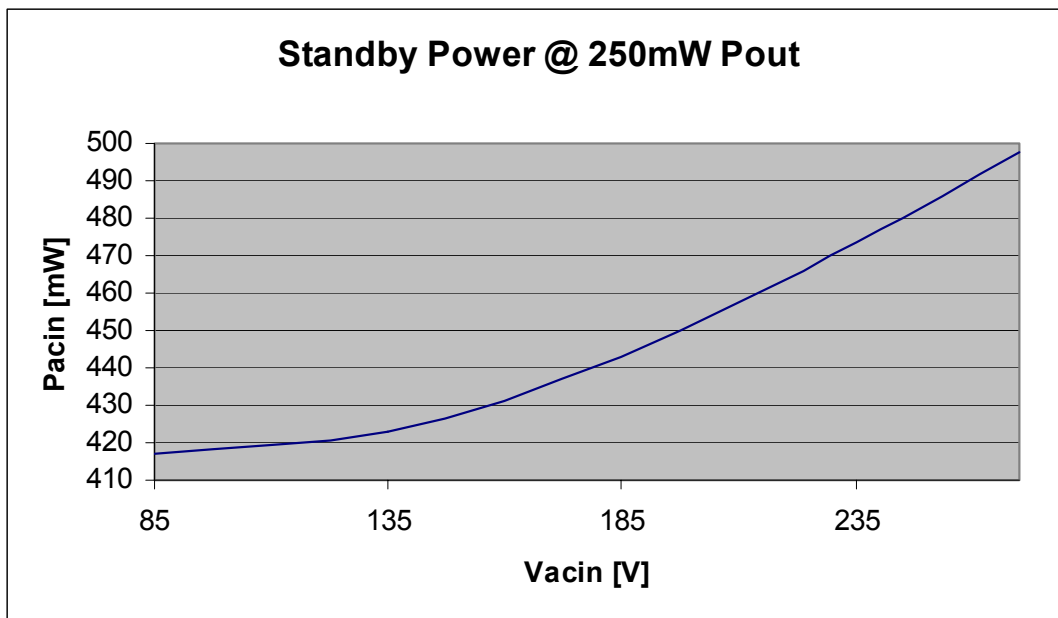

Fig. 6: Standby Power

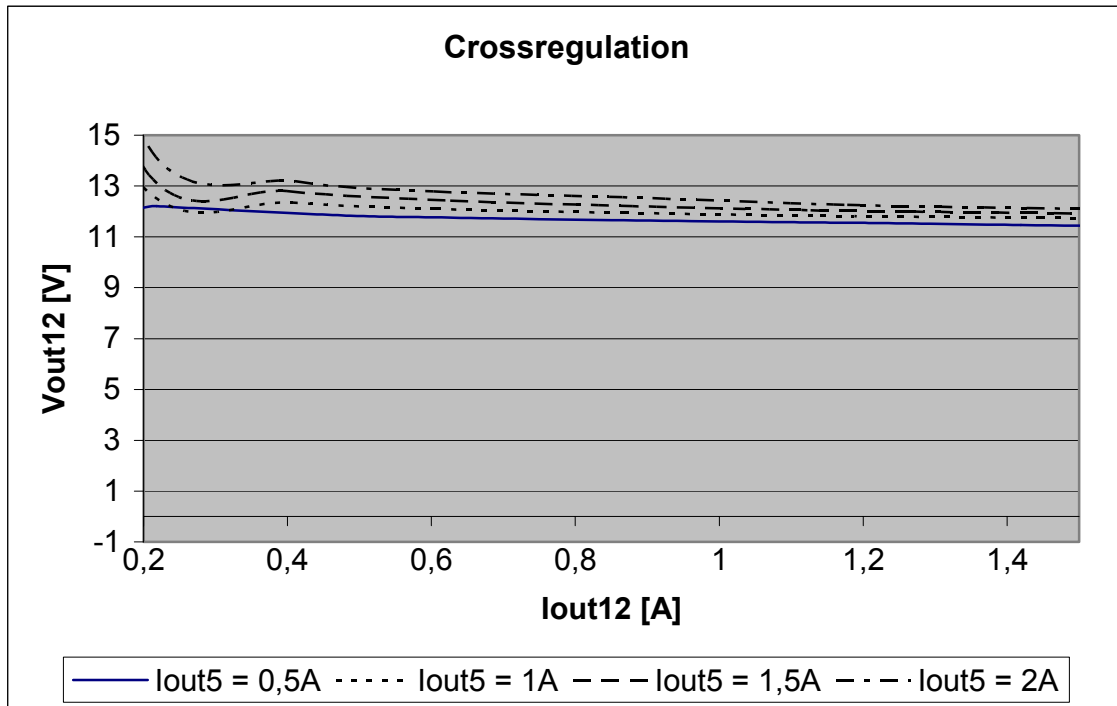

Fig. 7: Crossregulation

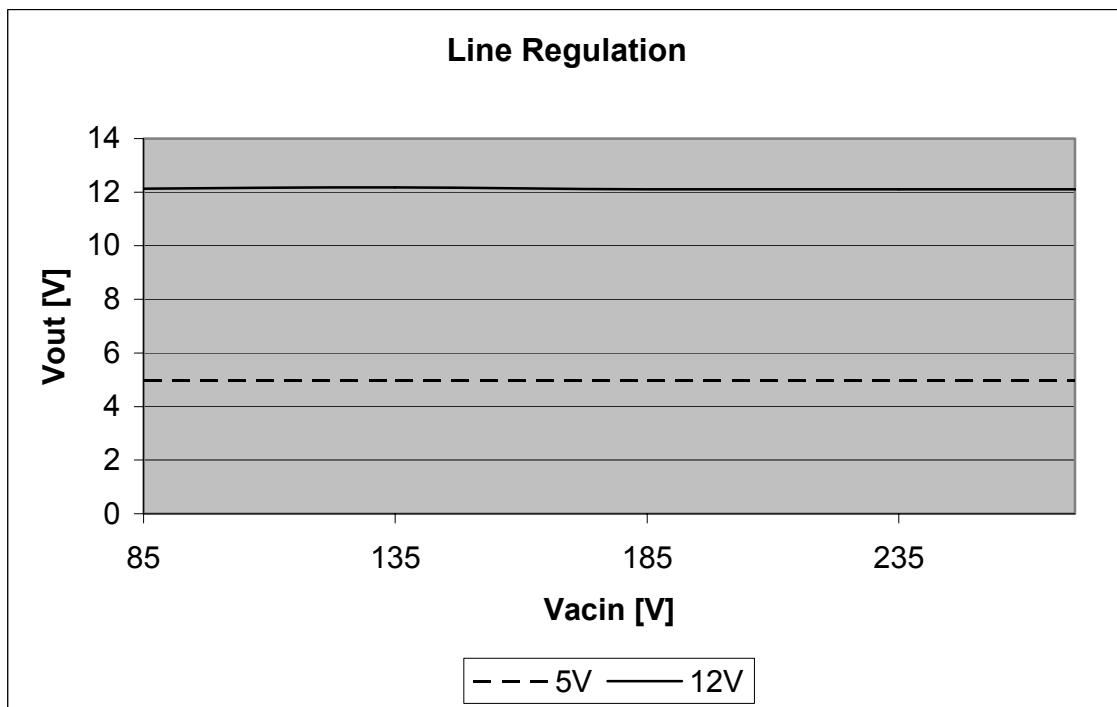
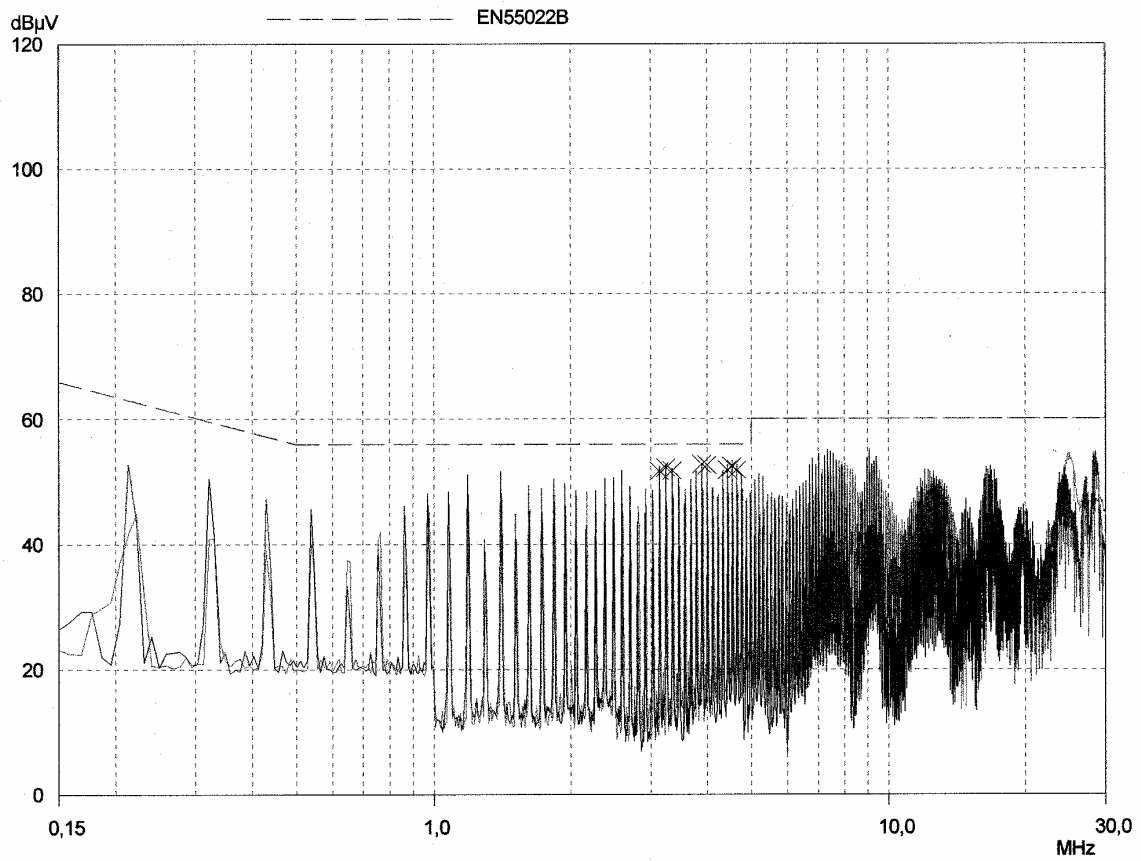

Fig. 8: Line Regulation



PAGE 1

Fig. 9: EMC Measurement

References

- [1] ICE3DS01G for OFF-Line Switch Mode Power Supplies
Application Note, Infineon Technologies
- [2] ICE2AXXX for OFF-Line Switch Mode Power Supplies
Application Note, Infineon Technologies
- [3] F2+
ICE3DS01G
Off-line SMPS Current Mode Controller with integrated 500V Startup Cell
Datasheet, Infineon Technologies

Note:

The built-in transformer does **not** comply with EN60950 safety requirements
in respect of electrical isolation.

Change service

Revision History		
Application Note EVALSF3-ICE3DS01G		
Actual Release: V1.1		Date:28.04.2003
		Previous Release: V1.0
Page of actual Rel.	Page of prev. Rel.	Subjects changed since last release
	-----	First Issue
15	15	Part List

For questions on technology, delivery and prices please contact the Infineon Technologies Offices in Germany or the Infineon Technologies Companies and Representatives worldwide: see the address list on the last page or our webpage at <http://www.infineon.com>

CoolMOS™ and **CoolSET™** are trademarks of Infineon Technologies AG.

We listen to Your Comments

Any information within this dokument that you feel is wrong, unclear or missing at all? Your feedback will help us to continously improve the quality of this dokument. Please send your proposal (including a reference to this dokument) to:
mcdoku.comment@infineon.com

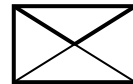

Edition 2001-03-01

Published by Infineon Technologies AG,
 St.-Martin-Strasse 53,
 D-81541 München

© Infineon Technologies AG 2000.
 All Rights Reserved.

Attention please!

The information herein is given to describe certain components and shall not be considered as warranted characteristics.

Terms of delivery and rights to technical change reserved.

We hereby disclaim any and all warranties, including but not limited to warranties of non-infringement, regarding circuits, descriptions and charts stated herein.

Infineon Technologies is an approved CECC manufacturer.

Information

For further information on technology, delivery terms and conditions and prices please contact your nearest Infineon Technologies Office in Germany or our Infineon Technologies Representatives worldwide (see address list).

Warnings

Due to technical requirements components may contain dangerous substances. For information on the types in question please contact your nearest Infineon Technologies Office.

Infineon Technologies Components may only be used in life-support devices or systems with the express written approval of Infineon Technologies, if a failure of such components can reasonably be expected to cause the failure of that life-support device or system, or to affect the safety or effectiveness of that device or system. Life support devices or systems are intended to be implanted in the human body, or to support and/or maintain and sustain and/or protect human life. If they fail, it is reasonable to assume that the health of the user or other persons may be endangered.

Infineon goes for Business Excellence

“Business excellence means intelligent approaches and clearly defined processes, which are both constantly under review and ultimately lead to good operating results.

Better operating results and business excellence mean less idleness and wastefulness for all of us, more professional success, more accurate information, a better overview and, thereby, less frustration and more satisfaction.”

Dr. Ulrich Schumacher